



in sink erator®

**FOOD SERVICE
FOOD WASTE DISPOSERS**



www.insinkerator.co.nz



A KITCHEN CAN'T RUN AT OPTIMAL PERFORMANCE UNTIL ITS DISPOSER DOES.

From lunch bars and restaurants to healthcare facilities and education institutes, our food waste disposers help food service operations run at peak performance, enhancing day-to-day productivity by increasing staff efficiency, reducing operating costs and improving kitchen sanitation.

REDUCES FOOD WASTE AS WELL AS IT REDUCES INEFFICIENCY.

Food waste that decomposes in rubbish skips creates odours, attracts pests and serves as a breeding ground for bacteria. Disposers help keep food waste out of rubbish skips. They also reduce staff trips to the bin and waste-hauling costs, while increasing kitchen efficiency and profitability. Bottom line? Food waste disposers play an important role in saving your operation money with payback of initial investment in as little as one year.

ENVIRONMENTAL BENEFITS

Each year in New Zealand, tonnes of food waste is trucked to landfills. Once there, it quickly decomposes and produces methane, which escapes into the environment. Methane is an environmentally harmful greenhouse gas at least 21 times more potent than CO₂. Our food waste disposers provide a convenient and environmentally friendly alternative to transporting leftovers to landfills. Plus, capable wastewater treatment plants can even recycle food scraps into energy and fertilizer.

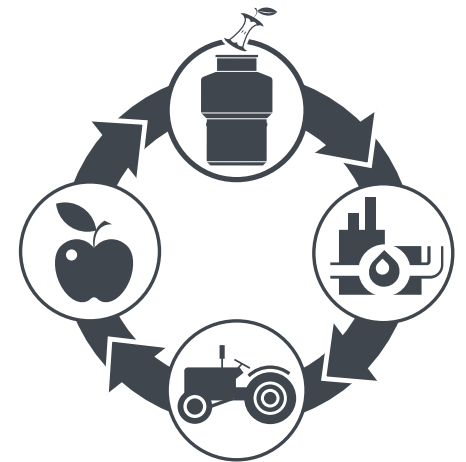



AN IDEA IS BORN AND A BRAND IS BUILT.

The InSinkErator brand was established in 1938. Today, we're the world's largest manufacturer of food waste disposers for home and commercial use. As the undisputed leader in quality and reliability, our products are renowned for maximum energy efficiency and long-lasting durability.

5 MODELS. COUNTLESS OPPORTUNITIES FOR PRODUCTIVITY.

With five different models, we have a food waste disposer for any size operation. From the light-duty LC-50 to our large capacity SS-500 workhorse model, all disposers feature stainless steel grind chambers, dual-direction cast iron shredders and heavy-duty motors for quiet operation and superior performance.



BUILT SMART, TOUGH & RELIABLE.

Durable construction, superior performance and reliable dependability make InSinkErator New Zealand's best-selling food waste disposer.





CHOOSING A DISPOSER IN THREE EASY STEPS.

Simply follow these three steps to maximise your efficiency, productivity and profitability while minimising your impact on the environment.

1. STEP ONE: CHOOSE A FOOD WASTE DISPOSER



Choose the right disposer for your kitchen. Whether a small lunch-bar or a large cafeteria, InSinkErator have a model to suit. Choose from the chart on the following page.

2. STEP TWO: CHOOSE A COLLAR OR BOWL



Choose a collar to fit any sink opening and a bowl sink assembly designed for dish tables or drainboards.































3. STEP THREE: CHOOSE A CONTROLLER



Start with a simple on-off switch, or select a multi-function control with reversing features and time delay relays that allow water to continue running after the disposer is turned off.

CHOOSE THE RIGHT FOOD WASTE DISPOSER

This chart is an indication of the best model to suit the amount and sort of food waste you deal with.

PERSONS PER MEAL	INSINKERATOR DISPOSER RECOMMENDATION				
UP TO 150	 LC-50	 LC-50	 SS-100	 SS-100	 SS-200
150-200	 SS-100	 SS-100	 SS-100	 SS-200	 SS-200
200-300	 SS-100	 SS-100	 SS-200	 SS-200	 SS-300
300-750	 SS-100	 SS-200	 SS-200	 SS-300	 SS-300
750-1,500	 SS-200	 SS-200	 SS-300	 SS-500	 SS-500
1,500-2,500	 SS-200	 SS-200	 SS-300	 2X SS-500	 SS-500
OVER 2,500	CONTACT YOUR INSINKERATOR REPRESENTATIVE				
KITCHEN APPLICATION	POT SINK	SALAD PREP AREA	VEGE PREP AREA	SOLID DISH TABLE	MEAT/SEAFOOD PREP
FOOD WASTE COMPOSITION	LIGHT (MOSTLY FRUIT & VEGES)		MEDIUM (50/50 MIX OF VEGES & MEAT)		HEAVY (MOSTLY MEAT)



1. STEP ONE: CHOOSE A DISPOSER

Whether you serve 25 or 2,500 people, there's an InSinkEerator food waste disposer for you. To determine the most suitable disposer for the demand, volume and type of food waste, refer to the sizing chart on the previous page.

LC-50 - Small Capacity



Designed for small food service establishments such as restaurants and assisted living facilities.

- 0.5HP induction motor
- 230V
- 1 Phase
- Height: 362mm
- 150mm diameter rotating shredder
- 1.5" waste outlet
- Part #: LC-50

SS-100 - Small Capacity



Designed for small food service establishments such as restaurants and assisted living facilities.

- 1 HP induction motor
- 230V
- 1 Phase
- Height: 431mm
- 150mm diameter rotating shredder
- 1.5" waste outlet
- Part #: SS 100-35

SS-200 - Medium Capacity



Designed for medium size establishments such as schools, hospitals, large restaurants, hotels, cafeterias and nursing homes.

- 2 HP induction motor
- 460V
- 3 Phase
- Height: 488mm
- 174mm diameter rotating shredder
- 2" waste outlet
- Legs supplied but not installed
- 3 Phase
- Part #: SS 200-39

SMALL

MEDIUM

SS-300 - Large Capacity



Designed for large establishments such as banquet facilities, hospitals, universities and military facilities.

- 3 HP induction motor
- 460V
- 3 Phase
- Height: 790mm
- 228mm diameter rotating shredder
- 3" waste outlet
- Legs factory installed
- Part #: SS 300-21

SS-500 - Large Capacity



Designed for large establishments such as banquet facilities, hospitals, universities and military facilities.

- 5 HP induction motor
- 460V
- 3 Phase
- Height: 790mm
- 228mm diameter rotating shredder
- 3" waste outlet
- Legs factory installed
- Part #: SS 500-23



LARGE

2. STEP TWO - CHOOSE MOUNTING AND BOWL

Our disposers include two types of stainless steel collar adapters and a sink flange adapter to accommodate any size sink opening. We also offer a variety of bowl sink assemblies designed for dish tables and drainboards.

DISPOSER MOUNTINGS

No. 5 Sink Flange



- 89mm - 102mm sink opening
- Stopper & splash baffle
- No Welding Required
- Part #: IPS12506

No. 5 Short Sink Flange



- 89mm - 102mm sink opening
- Stopper & splash baffle
- No Welding Required
- Short version for limited space under sink
- Part #: IPS12506C

No. 6 Collar Assembly



- For trough applications
- Welding required for installation
- Fits 6-5/8" sink opening
- Includes mounting adapter for mounting disposer
- Part #: IPS11248 - Collar adaptor only
- Part #IPS12504 - Collar adaptor incl. splash baffle

No. 7 Collar Assembly



- 168mm sink opening
- Removable splash baffle
- For welding into stainless steel troughs
- Includes mounting adapter for mounting disposer
- Part #: IPS12505 (Includes stopper)
- Part #: IPS11617 (Stopper only)
- Part #: IPS1005 (Removable splash baffle)

DISPOSER SWIRL BOWLS



- Either 305mm, 457mm bowls
- Part #: IPS1005 - Removable splash baffle
- Baffle sits 13mm proud of bowl to help prevent silverware loss
- Part #: IPS12503A (305mm), IPS12501B (457mm)

ACCESSORIES ALSO AVAILABLE

Silver Sleeve Guard



- Sits in sink to prevent silverware from dropping into disposer
- Part #: IPS11249

Bowl Cover



- Sizes available: 305mm, 457mm
- Reversible bowl cover for either flush mounted to provide a larger working area, or inverted for greater waste confining recessed area
- Part #: IPS11013 (305mm), IPS11011 (457mm)

3. STEP THREE - CHOOSE A C

Our controllers provide automated operations, like reversing features and time delay relays that allow water to run after the disposer is turned off. With additional accessories, our controllers can use one button to activate both the disposer power and water flow for the most efficient use of water.

Manual One Direction - MS



- Push button ON/OFF switch
- High impact polycarbonate construction
- NEMA 4 - Water tight enclosure
- Single direction only
- Magnetic starter/provides auto shut-off in case of power interruption
- Operates on line voltage

VOLTAGE/PHASE AVAILABILITY

Model	Part #:	Voltage/Hz	Phase	Disposer Models
MS-8	IPS15260A	208-240V, 50 Hz	1 Ph	LC50 and SS-100
MS-10	IPS15260C	380-460V, 50 Hz	3 Ph	SS-200, SS-300 and SS-500

RECOMMENDED INSTALLATION & DIMENSIONS

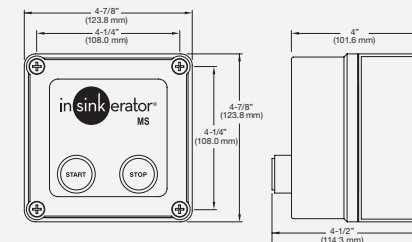
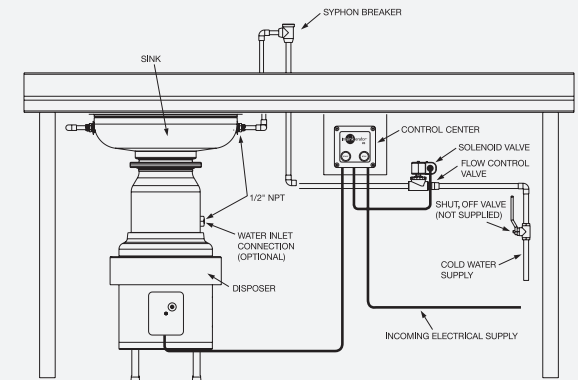

ONTROLLER

Manual Reversing - MRS



- 3-button switch with FWD/STOP/REV
- Stainless steel construction
- NEMA 4 - Water tight enclosure
- Manual reverse, increasing cutting element life
- Magnetic starter/provides automatic shut-off in case of power interruption
- Operates on line voltage

VOLTAGE/PHASE AVAILABILITY

Model	Part #:	Voltage/Hz	Phase	Disposer Models
MRS-15	IPS15259A	208-240V, 50 Hz	1 Ph	LC50 and SS-100
MRS-17	IPS15259C	380-460V, 50 Hz	3 Ph	SS-200, SS-300 and SS-500

RECOMMENDED INSTALLATION & DIMENSIONS

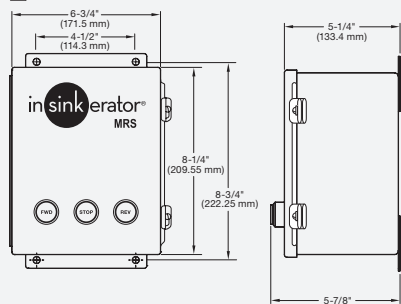
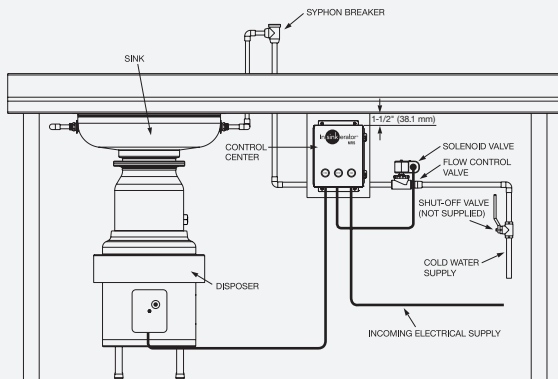

AQUASAVER® Water Saving Contoller - AS-101



The AquaSaver® control center provides an on-demand water-saving system for InSinkErator foodservice disposers. The AS-101 control center senses the load of the disposer and regulates the amount of water necessary for grinding and non-grinding situations.

- Stainless steel construction
- NEMA 4 - Water tight enclosure
- Reverses direction at each startup
- Increases cutting element life
- Reversing delay, disposer will not reverse while motor is in motion
- Protects motor from burn out from operator misuse
- Automatic drop out system
- If a power loss occurs, control automatically disengages power
- Operates on Solid State 24V
- Printed circuit board with control diagnostic/function lights, delay timers and timed run pin and reversing control
- Post Water Flush Adjustable timer allows water to run automatically for up to 10 minutes, flushing disposer and drain lines after disposer is shut off
- Timed Run or Continuous Run- Selected at your discretion, simply by moving the plug-in in on the printed circuit board
- Timed run shuts off disposer automatically after 10 minutes
- Can be shut off manually any time
- Solenoid Valve - packed inside control centre carton

VOLTAGE/PHASE AVAILABILITY

Model	Part #:	Voltage/Hz	Phase	Disposer Models
AS101K-6	IPS15255A	208-240V, 50 Hz	1 Ph	LC50 and SS-100
AS101K-8	IPS15255C	380-460V, 50 Hz	3 Ph	SS-200, SS-300 and SS-500

RECOMMENDED INSTALLATION & DIMENSIONS

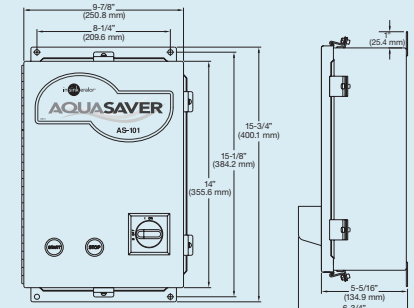
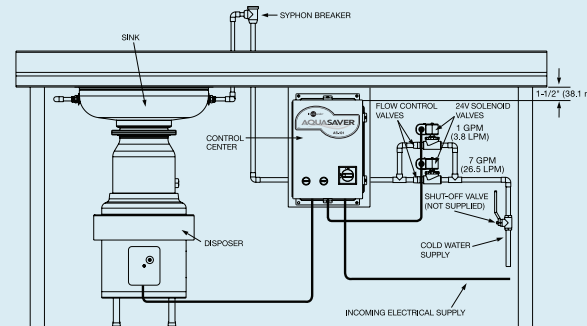

WATER CONTROL OPTIONS

TO BE USED IN CONJUNCTION WITH CONTROLLERS

For assistance, please consult our Technical Team.

Solenoid Valve



- Activates water when disposer is turned on
- Deactivates when disposer is turned off
- Part #: IPS 14496 - Single Phase Solenoid (230v)
- Part #: IPS 14497 - 3 Phase Solenoid (400v)
- Part #: IPS13956 - Water Inlet Kit

Syphon Breaker



- Prevents water back-flow from syphoning back into the water line
- Part #: IPS11477

Flow Control Valve



- Limits excessive water consumption
- Provides the correct amount of water (GPM) to the disposer
- Part #: IPS13763A - 11.3 LPM or 3 GPM

Adjustable Support Legs



- Sold in sets of two legs
- Two support legs can be added to small or medium size disposers for added stability
- Three support legs are included with all disposers except Model LC-50 and SS-100
- Part #: IPS11757C

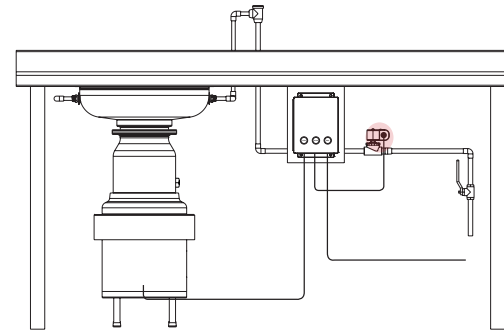
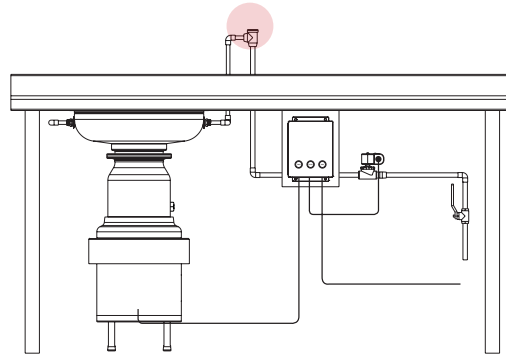
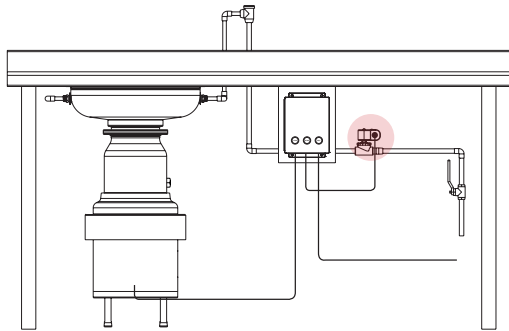

Flange Leg Foot



- Provides secure floor mounting
- Use anywhere extra stability is needed
- Flange foot is sold individually with one set of screws
- Order two feet for medium sized units and three for large units
- Not included with Adjustable Support Legs
- Part#: IPS14394

Model	Part#	Standard	Optimal (With valve)
SS-100	IPS13763B	18.9 LPM / 5.6 GPM	11.4 LPM
SS-200	IPS13763C	26.5 LPM / 7.6 GPM	18.9 LPM
SS-300	IPS13763D	30.3 LPM / 8 GPM	26.5 LPM
SS-500	IPS13763D	30.3 LPM / 8 GPM	26.5 LPM

LPM (Litres Per Minute) / GPM (Gallons Per Minute)

Throat Guard

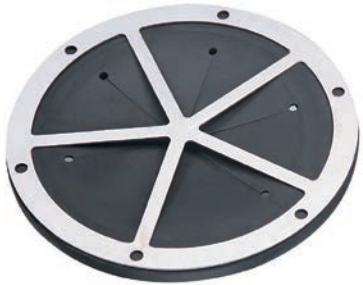

- Throat Guard mounts at the throat opening of disposer
- Keeps hand safely away from disposer grind chamber
- Can not be removed while disposer is installed
- Fits any disposer with a standard throat opening
- Includes gasket and mounting bolts
- Part #: IPS13620

Silver Sleeve Guard



- Sits in sink to prevent silverware from dropping into disposer
- Part #: IPS11249

Swirl Bowl Cover



- Sizes available: 305mm and 457mm
- Removable splash baffle
- Reversible bowl cover for either flush mounted to provide a larger working area, or inverted for greater waste confining recessed area
- Part #: IPS11013 (305mm), IPS11011 (457mm)

Offset Chute

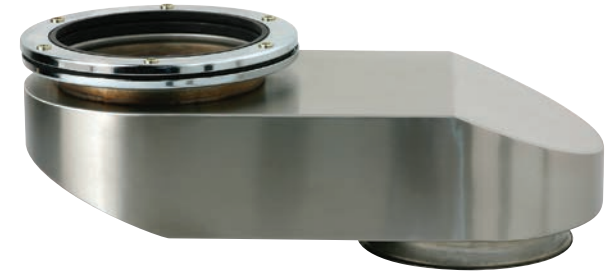

- Mounts between the disposer and sink bowl to limit access to disposer grind chamber
- Required in some areas or facilities to satisfy regulations
- Fits No. 6 & No. 7 collars
- Water nozzle included
- Part #: IPS114029

Splash Baffle



- Sits either on top of silver sleeve guard or directly in sink
- Used as a silver guard and scrap block
- Fits 168.2mm throat opening
- Part #: IPS11005

Magnetic Silver Saver



- Mounts to any trough system
- One Trough Magnetic Silver Saver approximately 450mm from disposer hole is recommended. Additional magnets along length of trough are optional.
- Part #: IPS13983

Dejamming Wrench



- Loosen and dislodge object in the grind chamber
- Only for use with 168.2mm opening
- Place the wrench over the shredder nut and stationary lugs located on the rotating shredder.
- Using the handle, rotate the wrench clockwise then counterclockwise to loosen the jam
- NOTE: After freeing the rotating shredder, remove all loose particles which may have caused the jam
- Cannot be used with 88.9mm opening
- Part #: IPS13993

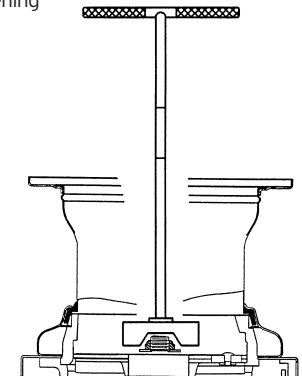



in sink erator®

FOOD SERVICE FOOD WASTE DISPOSERS

FOR MORE INFORMATION

FREE PHONE: 0800 200 510

EMAIL: info.parex@whirlpool.com

